



### Model Number

**V1-W-YE10M-PVC-U**

Female cordset, M12, 4-pin, PVC cable

### Features

- UL Recognized Component
- Knurled nut suitable for tool assembly
- Immunity to vibration, with mechanical latching
- Gold-plated and machined contacts
- Protection degree IP67 / IP68 / IP69K
- Flame resistant cable

### Dimensions

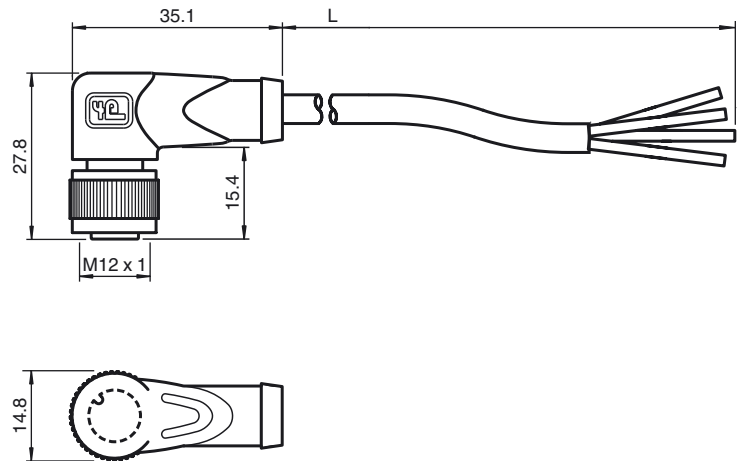

### Technical data

#### General specifications

Number of pins	4
Connection 1	socket
Construction type 1	right angle
Threading 1	M12
Connection 2	cable end
UL File Number	E231213

#### Electrical specifications

Operating voltage	$U_B$	max. 250 V AC/DC
Operating current		max. 4 A
Volume resistance		< 5 m $\Omega$

#### Ambient conditions

Ambient temperature	Body: -40 ... 90 °C (-40 ... 194 °F) cable, flexing: -25 ... 80 °C (-13 ... 176 °F) cable, fixed: -5 ... 80 °C (23 ... 176 °F)
Pollution Degree	3

#### Mechanical specifications

Contact elements	spring-loaded contact socket
Pin diameter	1 mm
Protection degree	IP67 / IP68 / IP69k
Material	
Contacts	CuSn / Au
Contact surface	Au
Body	TPU, black
Cable	PVC
Slotted nut	Diecast zinc
Core insulation	PVC
Cable	fine-strand, flexible
Sheath diameter	Ø 4.3 mm
Bending radius	> 15 x cable diameter, induced > 5 x cable diameter, fixed
Color	yellow
Cores	4 x 0.34 mm <sup>2</sup>
Conductor construction	19 x 0.15 mm Ø
Length	L 10 m
Flammability	
Contact material	HB
Housing	V-2
Cable	FT1

#### Compliance with standards and directives

Standard conformity	
Protection degree	EN 60529:2000
Standards	IEC 61076-2-101:2008

### Electrical connection

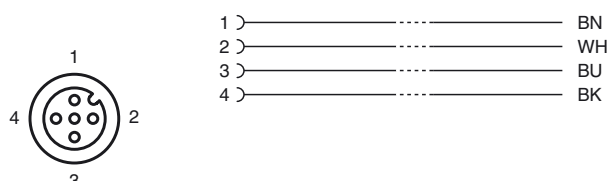



Flammability

Body: UL 94  
Line: UL 1581 Section 1061; IEC 60332-1-2:2004

**Approvals and certificates**

UL approval cURus AWM 2095 AWM I/II A/B 80°C 300V FT1 (cable)

Release date: 2013-08-14 16:29 Date of issue: 2013-08-14 456410\_eng.xml